

# TRACKING



# “General Provisions”

- The tracking terrain must meet the conditions given in the FCI IGP trial rules. **All natural soils may be used.**
- The judge or tracking coordinator determines the layout of the tracks.
- The layout should be adapted to the terrain.
- The different tracks must have different layouts.

# **“General Provisions”**

**Regarding motivational  
objects:**

**No motivation objects can be  
in the handler's possession at  
any time on the tracking field.**

# “General Provisions”

- The scent pad is to be marked by a “start flag”.
- The “start flag” is to be put immediately to **the left of the scent pad, next to the tracklayer.**
- The order in which the participants track is to be determined by drawing lots. The judge must see to this

# IGP 1 - 3 Phase "A"

## "Laying the tracks"

- Prior to laying the tracks the tracklayer/dog handler must show the articles to the judge or the tracking coordinator.
- The tracklayer must linger briefly at the start of the track.
- The track is to be laid in *normal paces* in the specified direction.
- *The corners are also to be laid in normal paces.*

# IGP 1 - 3 Phase "A"

## "Laying the tracks"

- The corners has to be **"closed corners"**. (in the regulations)

Winkel rechts

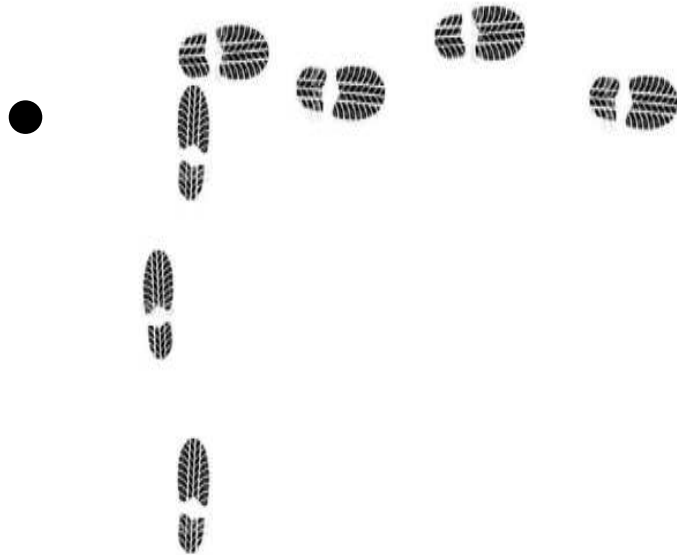

Winkel links

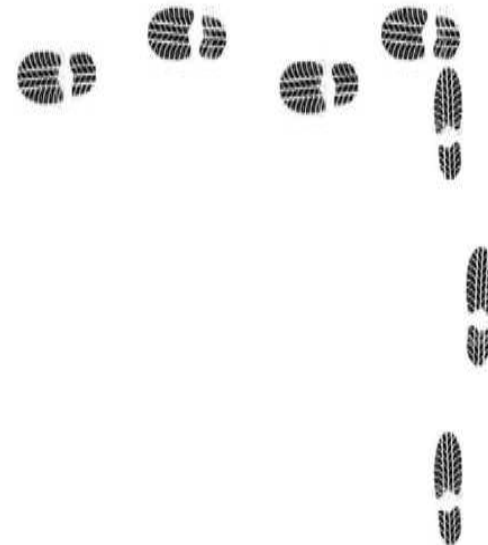

# "Laying the tracks"

- While the IGP 1 – tracks are being laid, **the dog** must be out of sight.
- While the IGP 2 + 3 – tracks are being laid, **the dog handler and dog** must be out of sight.
- Articles are not to be laid within 20 paces before or 20 paces after a corner.

# **REPORT IN**

- **Must be done in the basic position.**
- **The dog is allowed to be reported in on a short leash.**
- **The dog must be ready to track.**
- **Report the way of indicating or retrieving.**
- **Report out must be done in the basic position.**



# Requirements IGP 1

Handler-laid, **minimum 300 paces**, 3 legs, with 2 corners (about 90°), 3 articles, aged at least 20 minutes. On judge instruction: **1st article on the first leg, 2<sup>nd</sup> article on the 2<sup>nd</sup> leg, 3th article at the end of the track.** Tracking must be completed in **15 minutes**.

## Distribution of points:

|                     |                   |
|---------------------|-------------------|
| Following the track | 79 Points         |
| Articles (3 x 7)    | 21 Points         |
| <b>Total</b>        | <b>100 Points</b> |

## Possible layouts of tracks

Each may be to the left or to the right

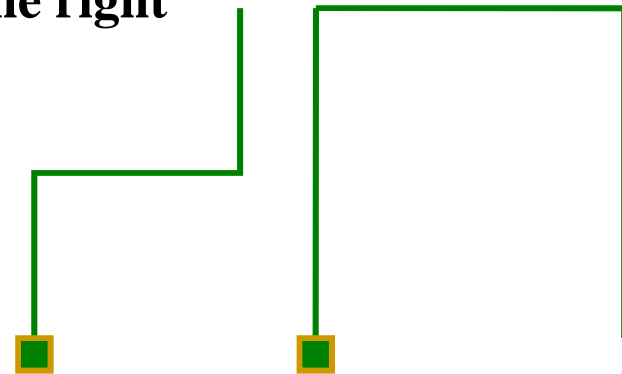

# Requirements IGP 2

Laid by a tracklayer, **minimum 400 paces**, 3 legs, with 2 corners (about 90°), 3 articles, aged at least 30 minutes. **1st article after min. 100 paces, 2<sup>nd</sup> article on the 2<sup>nd</sup> leg and 3th article at the end of the track.** Track must be completed in **15 minutes.**

## Distribution of points:

|                     |                   |
|---------------------|-------------------|
| Following the track | 79 Points         |
| Articles (3 x 7 )   | 21 Points         |
| <b>Total</b>        | <b>100 Points</b> |

## Possible layouts of tracks

Each may be to the left or to the right

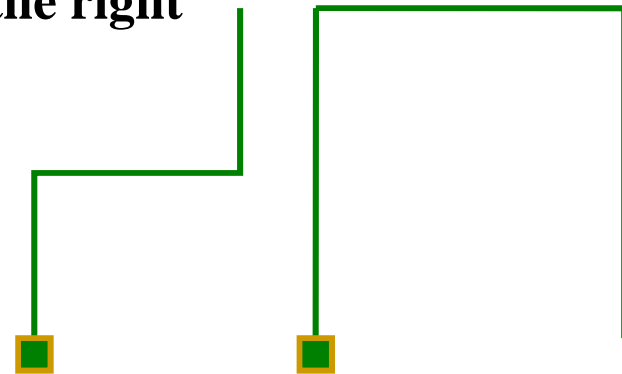

# Requirements IGP 3

Laid by a tracklayer, **minimum 600 paces**, 5 legs, with 4 corners (about 90°), 3 articles, aged at least 60 minutes. 1st article after min. 100 paces, 2<sup>nd</sup> article on the 2<sup>nd</sup> OR 3<sup>rd</sup> leg and 3th article at the end of the track.

Track must be completed in **20 minutes**.

**Possible layouts of tracks**

Each may be to the left or to the right

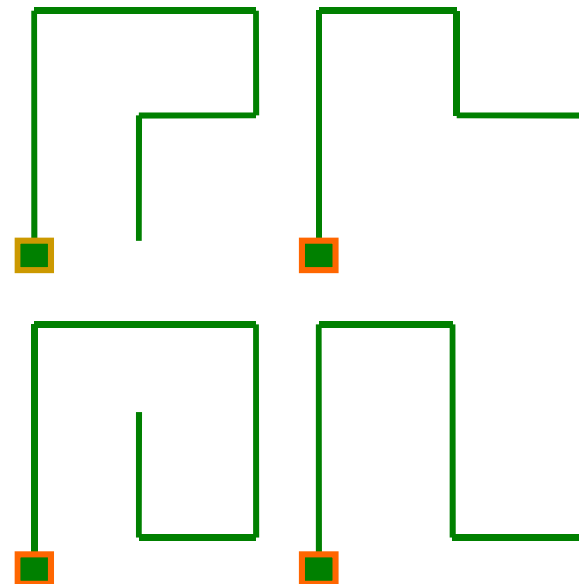

**Distribution of points:**

|                     |            |
|---------------------|------------|
| Following the track | 79 Points  |
| Articles (73 x 7)   | 21 Points  |
| Total               | 100 Points |

# **IPO 1 - 3 Phase "A"**

**Handler help through unnatural motion**

**–in the entire area of the track, in particular, near corners,**

**–near change of terrain,**

**–before placing the articles (IGP 1)**

**Will lead to deduction of the score**

## **“Starting the track”**

**It is not faulty at the start of the track for the dog to be slightly ahead of the handler as they approach the track as long as the dog is calm.**

**Evaluation of tracking, begins at the start of the track!**

**This is at the starting flag!!**

# Tracking

- If, with the permission of the judge, the dog is downed by the handler during the track for wild game or to untangle line around the legs:
- The restart is done with the handler **at the END of the line.**
- If downed for game, the handler stays at the end of the line.
- If downed to untangle, the handler goes to the dog, untangles the line **then returns to the end of the line to restart from there.**

# Tracking

- In certain situations the dog will track with an open muzzle.
- **This is not faulty**, because in some situations the dog will use also the special place in the palate of the dogs mouth.
- This special place is connected to the so called “Jacobson organ” and helps the dog in difficult situations to identify the scent.

# The Dogs mouth

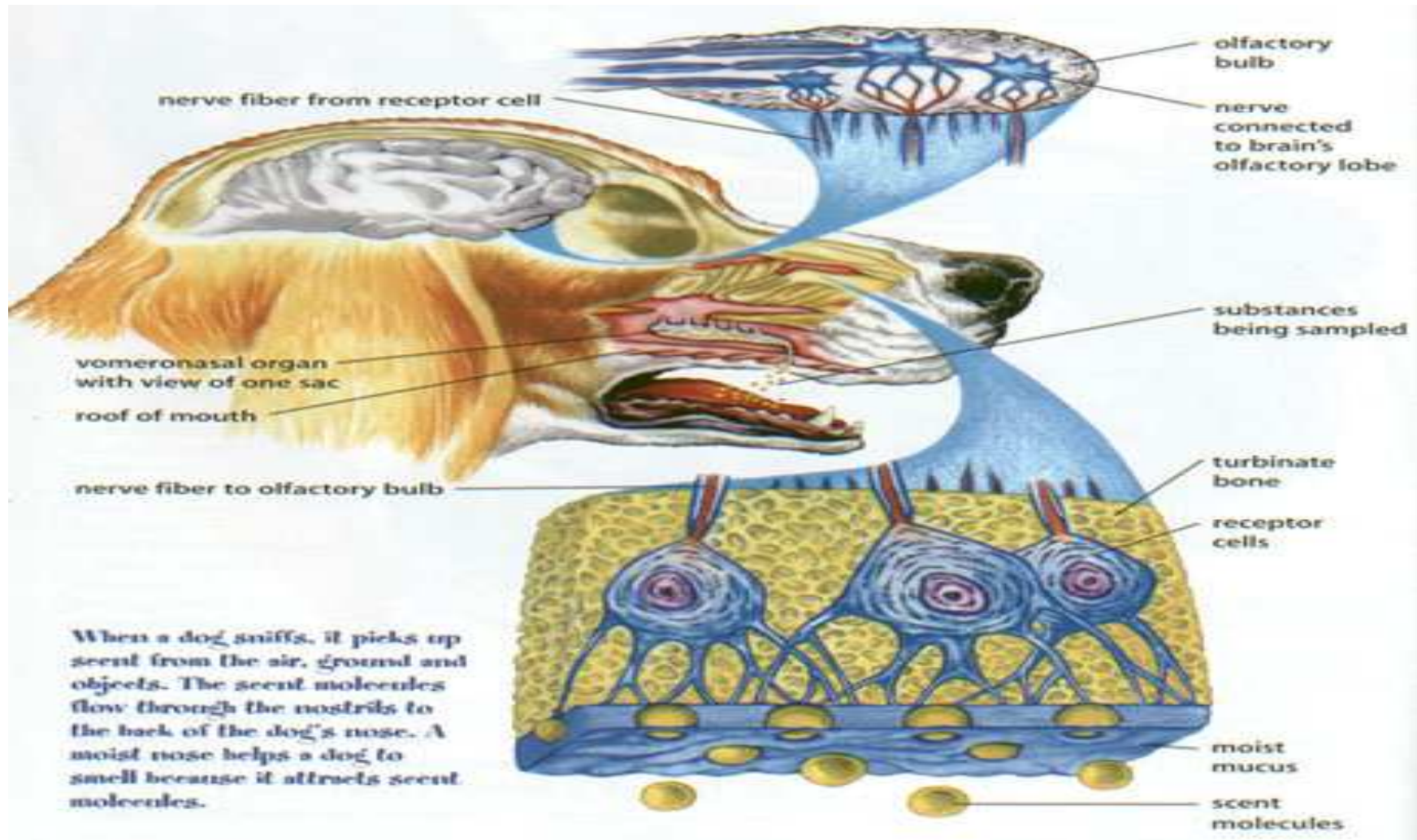



# IGP 1 - 3 Phase "A"

## "Starting the track"

- The start of the track:

Inspection by the dog of the scent path does **not depend on duration.**

It is **not** a criteria for a negative evaluation.

# IGP 1 - 3 Phase "A"

## "Starting the track"

- **Desirable is ...**
  - A calm and confident start
  - Picking up scent intensively and follows it convincingly.
- **Faults are ...**
  - Taking insufficient scent
  - Hectic and panicky start
  - Being under pressure at the start
  - Under force at the start
  - Avoidance at the start and when beginning to track

# HOW TO JUDGE

The start runs into the evaluation of the 1<sup>st</sup> leg.

IGP 1 and 2 = 1 x 27 (first leg)

2 x 26 points (second and thirth leg)

IGP 3 = 4 X 16 points (first four legs)

1 X 15 points (last leg)

After judgement of the work in qualification,  
the convection in points has to follow

# IFH-V

Handler laid track: Min. 600 paces.

5 legs and 4 corners. **1 of the 4 corners is a sharp corner ( between 30-60 degrees)**

Distance between corners at least 50 paces.

3 own articles: **1th article** after at least 100 on 1th or 2nd leg. 2nd article on 2nd or 3th leg.

3th article at the end of the track. **Points 3x5 + 1x6.**

**Ageing time of track=90minutes.**

**Working time max. 20 minutes.**

**Pre-requisite: BH/VT**

# IFH-1

Strange track, at least 1200 paces.

**Legs: 7**      **Corners: 6** about 90 degrees.

Distance between corners at least 50 paces.

Stranger's articles: 4 strangs:

**3x 5 points + 1x 6 points**

1<sup>st</sup> article after a minimum of 100 paces from the start, 2nd and 3rd according to the track Layer sketch, 4th at the end.

**Ageing Time: 180 minutes.**

**Working Time: Maximum 45 minutes**

Prerequisite: **BH/VT**

# IFH-2

Strange track, at least 1800 paces

**Legs:** 8, of which 1 is a semicircle with 30mtr Radius.

**Corners:** 7 of which **at least 2 acute/ sharp corners (30-60 degrees).**

Distance between corners at least 50 paces.

Stranger's articles 7: **7x 3 points**

1st article after a minimum of 100 paces from the start, 2nd – 6th according to the Track layer sketch (**2 articles on one leg is permissible**), 7th at the end.

# IFH-2

**Ageing Time: 180 minutes.**

**Working Time Maximum: 45 minutes.**

**Cross track timing: 30 minutes before the start.**

**Prerequisite: BH/VT or IFH -1**

# IGP-FH

**2 X IFH-2, on 2 different days in one trial.**

**2 x 1800 Paces,**

**2 different places,**

**2 different track layers,**

**(2 different Judges.)???**



# Cross tracks

- **Cross tracks shall not be laid within 40 paces before or 40 paces after a corner.**
- **Cross tracks may not be laid in the first or in the last leg.**
- **Cross track may not cross a leg 2 times.**
- **Cross tracks shall not be laid in an angle under 60 degrees.**

# IGP-V

- Handler laid track. At least 200 paces
- Legs: 2. Corners: 1 about 90 degrees.
- Articles: **2 own articles.**
- Articles are to be placed on the track on Judge's instruction.
- Ageing time: **no**
- Working time maximum: **10 minutes**
- Working the track: **79 Points**
- Articles: **21 Points**
- Prerequisite: **BH/VT**

# IGP-ZTP

- Handler laid track. At least 300 paces.
- Legs: 3      Corners 2 about 90 degrees.
- Articles: **3 own articles**
- Articles are to be placed on the track on Judges instruction.
- Ageing time: **20 minutes**
- Working Time Maximum. **20 minutes**
- Working the track: **79 points**
- Articles: 3x7= **21 points**
- Prerequisite **BH/VT**

# “The legs”

The legs are to be worked out with positive tracking behavior, intensive, with concentration and convincingly, with a deep nose and a uniform tracking tempo.

It is **not faulty** if ...

- The dog checks without leaving the track.

# “The legs”

- **Faults include ...**
  - **Partially high to high nose in parts or during the entire track**
  - **Circling**
  - **Insufficient intensity**
  - **Lack of concentration due to environmental influences**
  - **Under pressure and/or listless tracking**
  - **panicky and hectic tracking**
  - **Uncertainty und panicky behavior when solving problems**

# Behaviour on the legs

**The determining factor** for a positive, high evaluation in the overall behaviour on the legs is: **intensive, active yet calm tracking.**

You should “feel” the dog’s “desire to track”. Hunting dog judges speak of so-called: “will to find” .

# **“The corners”**

- What is the corner?**
- The corner is the point where two legs, in different directions, are connected.**
- How to judge the corner?**

# “The corners”

- The corners are to be worked out confidentially and with a “deep nose”.
- It is **not** faulty if ...
  - The dog checks to the left or right, without circling or leaving the track, when the direction changes, i.e. near an corner.
  - Over-running an corner by **one** pace



# **“The corners”**

- **Faults include ...**
  - **Large or small circles**
  - **Over-running corners by more than a pace**
  - **Faulty intensity at and after an corner**
  - **Lack of concentration due to environmental influences**
  - **Uncertainty and panicky behaviour when solving problems**
  - **Uncertainty in committing to the next leg**

# CORNERS

- **For all trial levels:** The evaluation of the corner runs into the next leg

## **IGP 1 und 2:**

1. Start and 1th leg = 26 Points

1th Corner and 2<sup>nd</sup> leg = 26 Points.

2nd Corner and 3<sup>rd</sup> leg = 27 Points.

79 Points

## **IGP 3:**

Firts leg (including the start) = 15 Points

Each corner and the following leg= 16 Points. (4x)

79 Points

# Corners

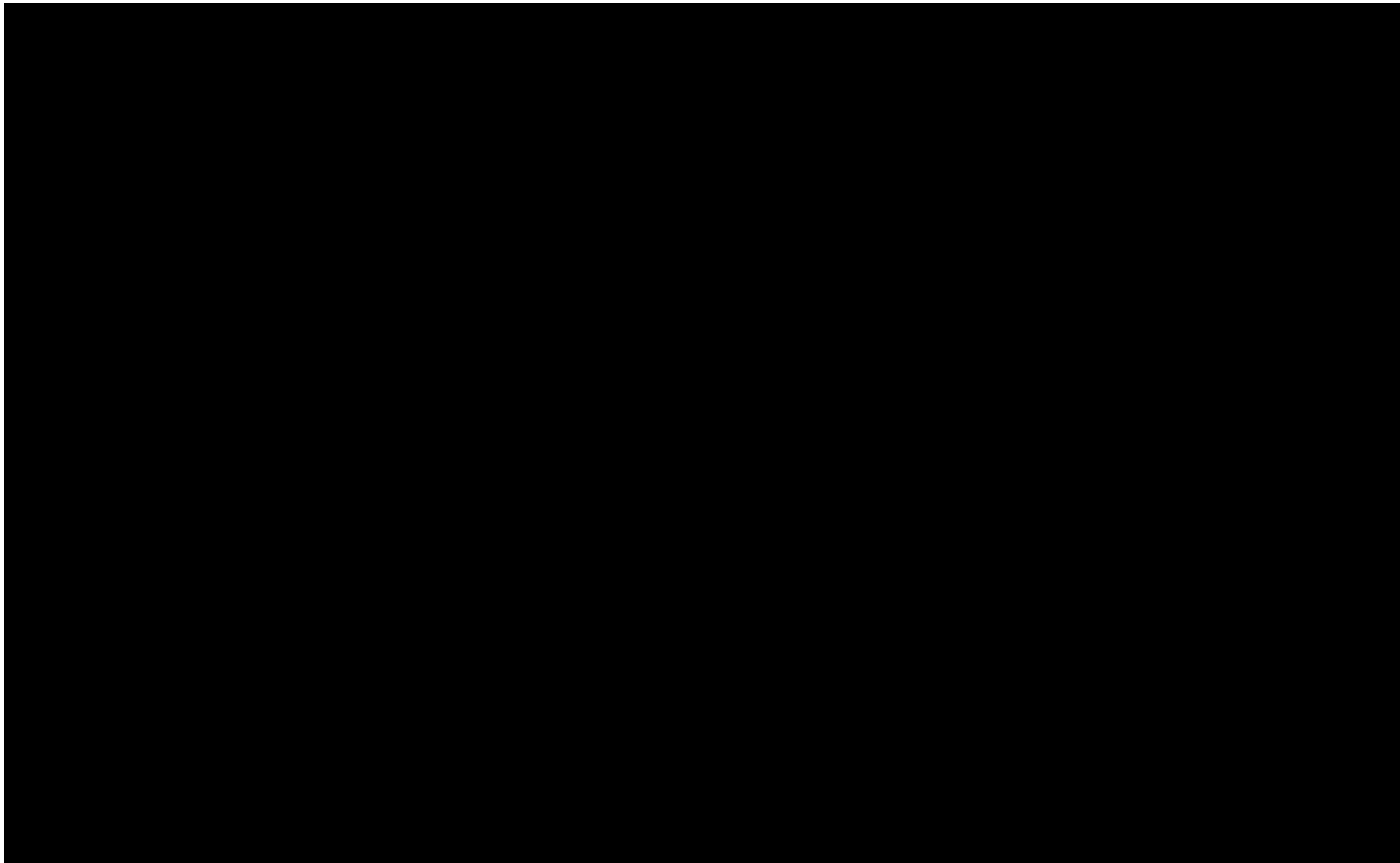

# **“The articles”**

- **Articles may not differ significantly in color from the terrain.**
- **Articles must shown to the judge before laying the track.**
- **In case of championships/ FH examinations the articles must be numbered according to the track number.**

# “The articles”

- Indicating the articles

The indication of the articles must be convincing. The speed with which a dog indicates is not necessarily a criterion for evaluation, it must be **consistent with the tracking tempo**.

- The desirable indication is if the dog ...

- indicates the article convincingly.
- indicates the article in a straight line to the track. **Indicating a little crooked is not faulty.**
- The article is indicated without hesitation.
- Remains calmly at the article until being restarted.
- **- Restart must be done on the side where the article was picked up.**

# “The articles”

- The **indication** is faulty if the dog ...
  - Doesn't indicate the article convincingly.
  - Indicates the article too early.
  - Indicates to the side of the article.
  - Lies on top of the article.
  - Is restless at the article.
  - Picks up the article, (**some dogs do so because of stress**) when otherwise reported to the judge.
  - Receives verbal “help” or “help” with the leash.
  - Anticipates the restart.

# “The articles”

- **Retrieve / Picking up the articles:**  
Picking up the article must be done immediately.
- **Desirable “picking up” is, if the dog:**
  - Picks up the article immediately.
  - Holds the article calmly and firmly in its mouth.
  - Brings the article directly to the handler.  
**(retrieve)**
  - remains calm until the restart.
  - **Restart must be done at the place where the article is taken.**

# “The articles”

- **“Picking up” is faulty if the dog...**
  - Picks up the article reluctantly and uncertainly.
  - Doesn't hold the article calmly in its mouth.
  - Drops the article.
  - Downs with the article. (**permitted is; stay, sit or retrieve**)
  - Goes forward with the article.
  - Doesn't want to give up the article. ( 3 comm allowed)
  - Receiving help, verbal or with the leash.
  - Anticipates the restart.



# “The articles”

- The handler may approach the dog from either side to pick up the article, **BUT they must then restart the dog from the SAME side they showed the article.**
- Praise is only allowed before or after picking up the article, not both.
- The dog must release / give the article with 3 or fewer commands or it will be DQ.

# The Articles

- **If an article that is not found by the dog and the Tracklayer can not find it, there will be no deduction.**
- **If several articles are not found, there will be a re-track.**
- **If a re-track is not accepted, the not found articles will be deducted.**
- **This is not the case in the tracks where the dog handler laid the tracks.**

# ARTICLES

- **For all examination levels:**

If the dog stops tracking by falsely indicating an article and the dog handler (HF) does **not go to the dog** but gives an extra command at the end of the tracking line “SEARCH”: **Deduction is -2 points.**

**In IFH-2 / IGP-FH - 1 point**

# Articles

- If the dog stops tracking by falsely indicating an article and the dog handler (HF) **does go to the dog**, and gives the tracking command at the side of the dog "Search" :

**Deduction is -4 points.**

**In IFH-2 / IGP-FH - 2 points**

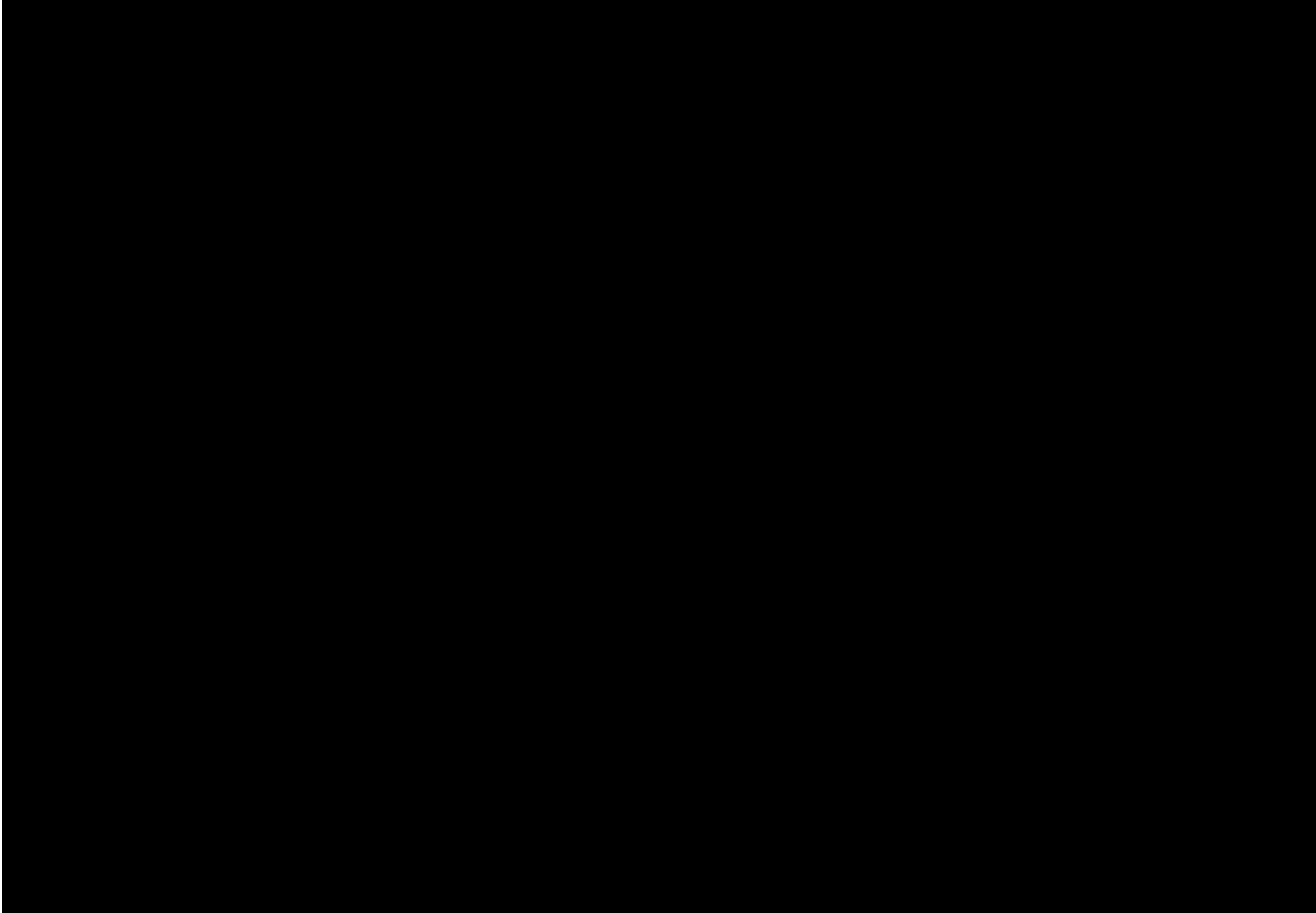

# “Tracking speed”

The tracking tempo is not a criterion for evaluation if the dog ...

- Works out **the entire track with the same tempo.**
- It is faulty if ...
  - The tracking tempo changes during portions<sup>\*)</sup> of the track
- In particular if ...
  - The tracking speed changes after a corner
  - The tracking speed changes after the start/restarts
  - The dog gallops

\*) Comment: Doesn't apply if the difficulty of the terrain changes during the course of the track.

# **Additional criteria for evaluation**

**Differences in tracking grounds**

**Nature of the soil**

**Disruption of the soil**

**Height of vegetation**

**Change of terrain**

**Cross-tracks (due to people or animals)**

**Influence of the weather (Rain, Snow)**

**Air pressure, humidity**

**High temperature**

**Heavy wind**

**Dampness of the ground**

# Tracking

In Phase A a dog must have learned during training, that in the ideal case it must be responsible for **100%** of the decisions.

***The dog must lead.***

The level of training can be seen in particular in the behavior at the start, at the corners, in committing to the legs following corners, and at the restarts after the indication of the articles.

Superficial behavior, long periods of inactivity as well as help of diverse forms must result in appropriate deductions.

The overall impression must be the deciding factor.



# **Judging Articles**



**Track** ↓

↑  
**Article**



Track

Article

**Track**



**Article**

**Track**



**Article**

**90° indicate**

**Track**

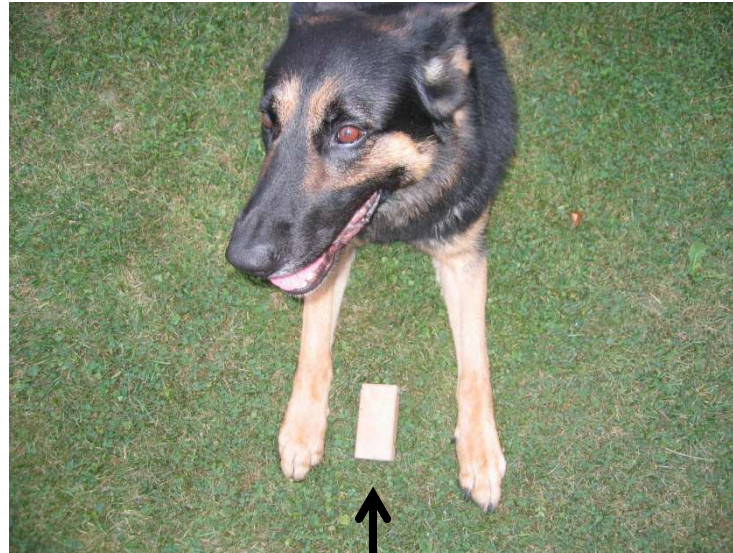

**Article**



**Track**

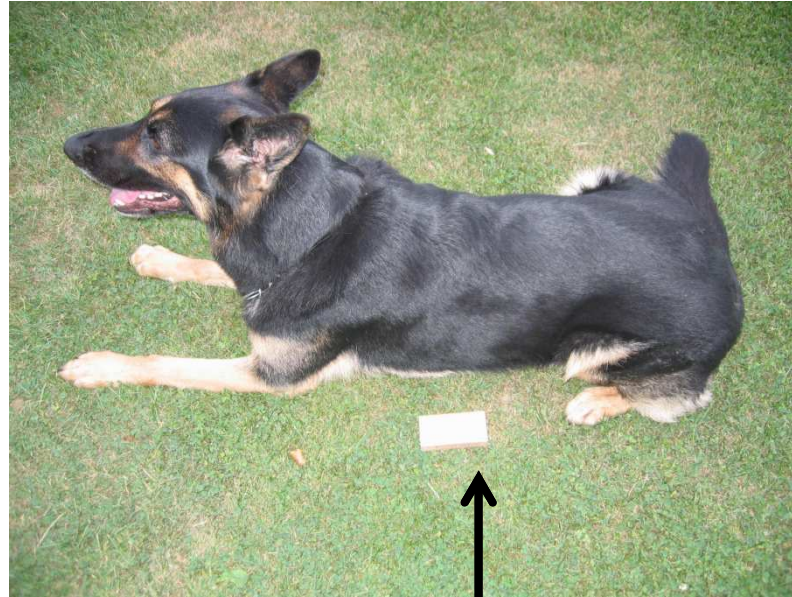

**Article**

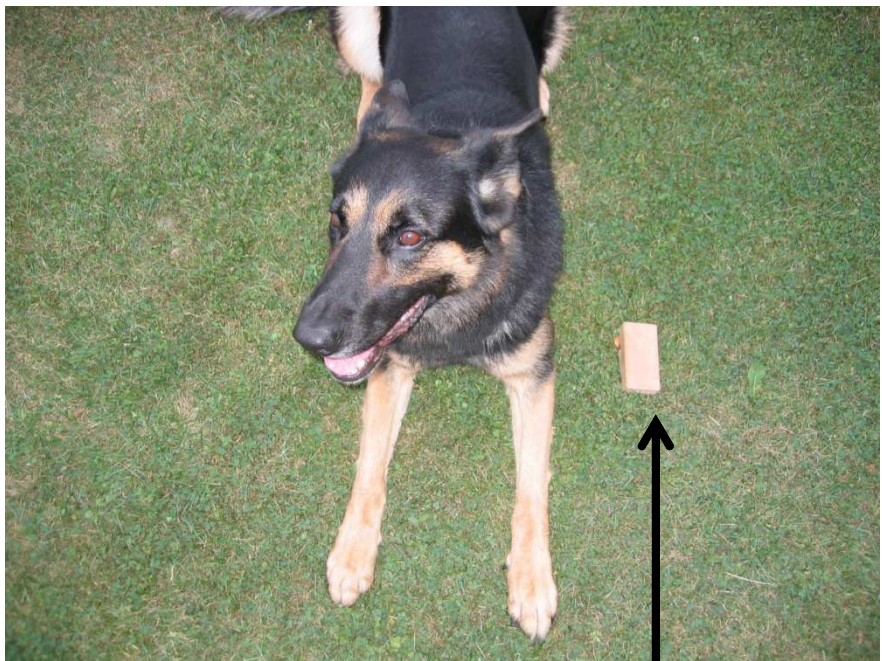

**Track**

**Article**



**Track**

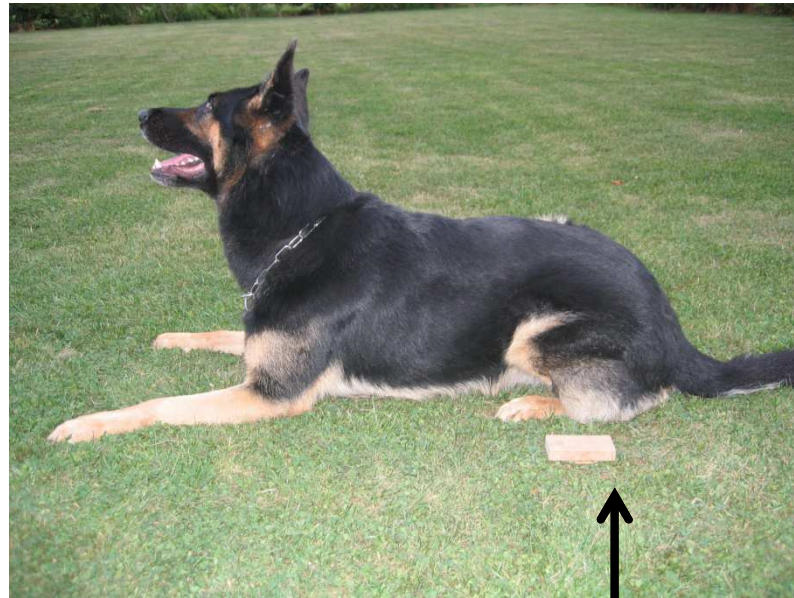

**Article**

**Track**



**Article**



**Article**



**Track**



**Track**

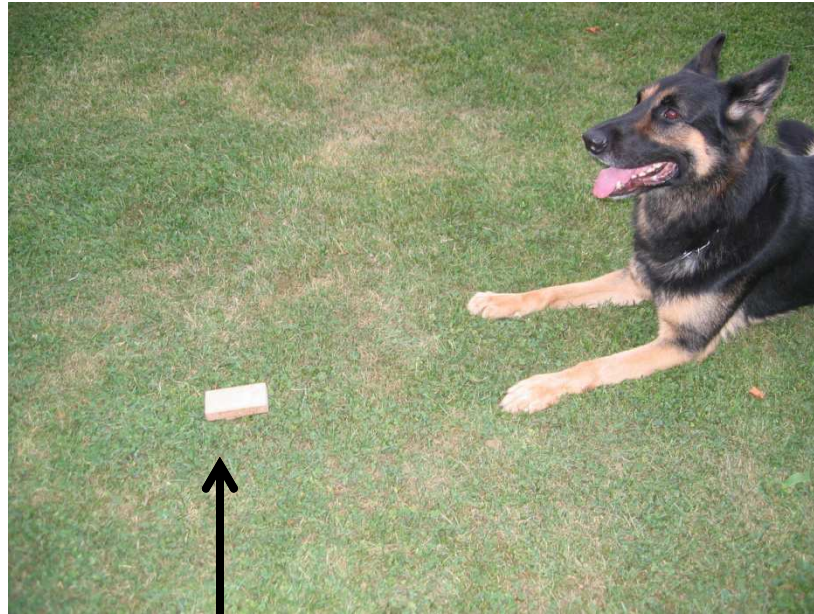

**Article**



**Article**



**Track**

# **Judging**

**How to judge tracking  
according to the  
FCI IGP Regulations**

# **JUDGING**

**The FCI IGP Regulations  
must be leading in the  
judgement of the judge**

# **Judging Tracking**

**A Judge must know**

**all the**

**FCI IGP Tracking**

**Regulations**



# Judging tracking

A judge must **not** judge  
according to **his personal**  
**interpretation** of the  
**FCI IGP Regulations.**

# **JUDGING TRACKING**

**To judge correctly, a Judge must know:**

- what is a track.**
- how to lay a track**
- what can/will influence the track.**
- the ideal picture of indicating.**
- difficulties of different soils.**
- How to lay / work out an FH track.**

# **JUDGING TRACKING**

- What is the moment of indicating an article?**
- What is, according to the IGP regulations, a correct indication?**

# **JUDGING Tracking**

**A Judge must be able to  
different between a local club  
trial and a Championship.**

# Judging Tracking

A Judge should **not**  
**“Kill”** the dog sport **by**  
his **judgement.**

He/ she must **also be a**  
**“Teacher”** for the dog  
**sporter**

# Judging Tracking

A Judge must be able  
to **“Read”** the  
**“body language”**  
of the dog.

# Body language??



# **Judging Tracking**

**A Judge must evaluate  
what he/she is seeing  
and not what he/she  
suspects.**



# **Judging Tracking**

**Before each exam /trial every judge should read once again the regulations.**

# JUDGING

**During the IGP Judge education seminars of the FCI, the way to judge, in an more equal way, by all judges, is discussed and agreements how to evaluate excersices are made. This must be spread to colleagues in the home countries.**

**THE END**

**THANK YOU FOR YOUR  
ATTENTION**